



PowerFlex 40 Adjustable Frequency AC Drive

FRN 5.xx - 6.xx

This Quick Start guide summarizes the basic steps needed to install, start-up and program the PowerFlex 40 Adjustable Frequency AC Drive. **The information provided Does Not replace the User Manual and is intended for qualified drive service personnel only.**

For detailed PowerFlex 40 information including EMC instructions, application considerations and related precautions, refer to the PowerFlex 40 *User Manual*, Publication 22B-UM001... at www.rockwellautomation.com/literature.

General Precautions



ATTENTION: The drive contains high voltage capacitors which take time to discharge after removal of mains supply. Before working on drive, ensure isolation of mains supply from line inputs [R, S, T (L1, L2, L3)]. Wait three minutes for capacitors to discharge to safe voltage levels. Failure to do so may result in personal injury or death.

Darkened display LEDs is not an indication that capacitors have discharged to safe voltage levels.



ATTENTION: Equipment damage and/or personal injury may result if parameter A092 [Auto Rstrt Tries] or A094 [Start At PowerUp] is used in an inappropriate application. Do not use this function without considering applicable local, national and international codes, standards, regulations or industry guidelines.



ATTENTION: Only qualified personnel familiar with adjustable frequency AC drives and associated machinery should plan or implement the installation, start-up and subsequent maintenance of the system. Failure to comply may result in personal injury and/or equipment damage.



ATTENTION: This drive contains ESD (Electrostatic Discharge) sensitive parts and assemblies. Static control precautions are required when installing, testing, servicing or repairing this assembly. Component damage may result if ESD control procedures are not followed. If you are not familiar with static control procedures, reference A-B publication 8000-4.5.2, "Guarding Against Electrostatic Damage" or any other applicable ESD protection handbook.



ATTENTION: An incorrectly applied or installed drive can result in component damage or a reduction in product life. Wiring or application errors, such as, undersizing the motor, incorrect or inadequate AC supply, or excessive ambient temperatures may result in malfunction of the system.

Mounting Considerations

- Mount the drive upright on a flat, vertical and level surface.

Frame	Screw Size	Screw Torque	DIN Rail
B	M4 (#8-32)	1.56-1.96 N-m (14-17 lb.-in.)	35 mm
C	M5 (#10-24)	2.45-2.94 N-m (22-26 lb.-in.)	–
B (IP66, Type 4X)	M6 (#12-24)	3.95-4.75 N-m (35-42 lb.-in.)	–

- Protect the cooling fan by avoiding dust or metallic particles.
- Do not expose to a corrosive atmosphere.
- Protect from moisture and direct sunlight.

Minimum Mounting Clearances

See Page 21 for mounting dimensions.

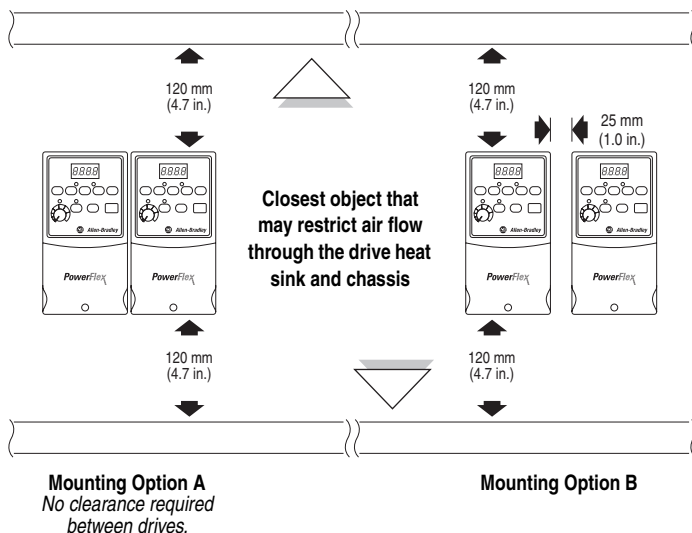

Ambient Operating Temperatures

Ambient Temperature		Enclosure Rating	Minimum Mounting Clearances
Minimum	Maximum		
-10°C (14°F)	40°C (104°F)	IP20, NEMA/UL Type Open	Use Mounting Option A
		IP66, NEMA/UL Type 4X	Use Mounting Option A
		IP30, NEMA/UL Type 1 ⁽¹⁾	Use Mounting Option B
	50°C (122°F)	IP20, NEMA/UL Type Open	Use Mounting Option B

⁽¹⁾ Rating requires installation of the PowerFlex 40 IP 30, NEMA/UL Type 1 option kit.

Typical Grounding

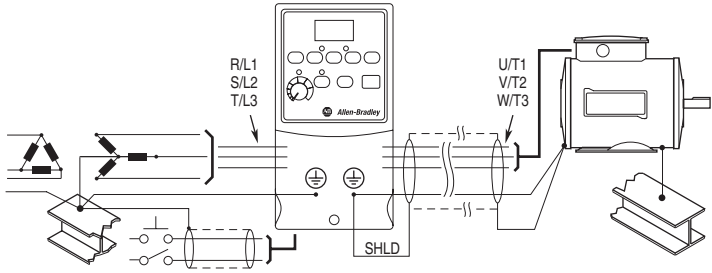

Disconnecting MOVs

To prevent drive damage, the MOVs connected to ground shall be disconnected if the drive is installed on an ungrounded distribution system where the line-to-ground voltages on any phase could exceed 125% of the nominal line-to-line voltage. To disconnect these devices, remove the jumper shown in the figures below.

1. Turn the screw counterclockwise to loosen.
2. Pull the jumper completely out of the drive chassis.
3. Tighten the screw to keep it in place.

Jumper Location

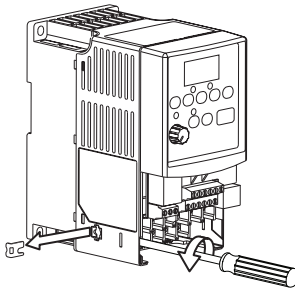

IP20, NEMA/UL Type Open

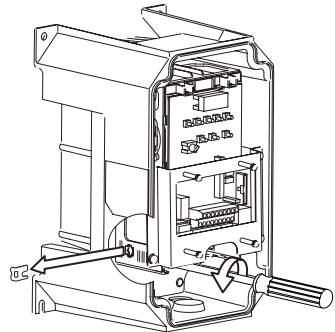

IP66, NEMA/UL Type 4X

Important: Tighten screw after jumper removal.

Phase to Ground MOV Removal

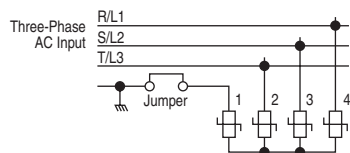

CE Conformity

Refer to the PowerFlex 40 *User Manual* for details on how to comply with the Low Voltage (LV) and Electromagnetic Compatibility (EMC) Directives.

Specifications, Fuses and Circuit Breakers

Drive Ratings

Catalog Number ⁽¹⁾	Output Ratings		Input Ratings			Branch Circuit Protection			Power Dissipation
	kW (HP)	Amps	Voltage Range	kVA	Amps	Fuses	140M Motor Protectors	Contactors	IP20 Open Watts
100 - 120V AC (±10%) – 1-Phase Input, 0 - 230V 3-Phase Output									
22B-V2P3x104	0.4 (0.5)	2.3	90-132	1.15	9.0	15	140M-C2E-C16	100-C12	40
22B-V5P0x104	0.75 (1.0)	5.0	90-132	2.45	20.3	35	140M-D8E-C20	100-C23	60
22B-V6P0x104	1.1 (1.5)	6.0	90-132	3.0	24.0	40	140M-F8E-C32	100-C37	80
200 - 240V AC (±10%) – 1-Phase⁽²⁾ Input, 0 - 230V 3-Phase Output									
22B-A2P3x104	0.4 (0.5)	2.3	180-264	1.15	6.0	10	140M-C2E-B63	100-C09	40
22B-A5P0x104	0.75 (1.0)	5.0	180-264	2.45	12.0	20	140M-C2E-C16	100-C12	60
22B-A8P0x104	1.5 (2.0)	8.0	180-264	4.0	18.0	30	140M-D8E-C20	100-C23	85
22B-A012x104	2.2 (3.0)	12.0	180-264	5.5	25.0	40	140M-F8E-C32	100-C37	125
200 - 240V AC (±10%) – 3-Phase Input, 0 - 230V 3-Phase Output									
22B-B2P3x104	0.4 (0.5)	2.3	180-264	1.15	2.5	6	140M-C2E-B40	100-C07	40
22B-B5P0x104	0.75 (1.0)	5.0	180-264	2.45	5.7	10	140M-C2E-C10	100-C09	60
22B-B8P0x104	1.5 (2.0)	8.0	180-264	4.0	9.5	15	140M-C2E-C16	100-C12	85
22B-B012x104	2.2 (3.0)	12.0	180-264	5.5	15.5	25	140M-C2E-C16	100-C23	125
22B-B017x104	3.7 (5.0)	17.5	180-264	8.6	21.0	30	140M-F8E-C25	100-C23	180
22B-B024x104	5.5 (7.5)	24.0	180-264	11.8	26.1	40	140M-F8E-C32	100-C37	235
22B-B033x104	7.5 (10.0)	33.0	180-264	16.3	34.6	60	140M-G8E-C45	100-C60	305
380 - 480V AC (±10%) – 3-Phase Input, 0 - 460V 3-Phase Output									
22B-D1P4x104	0.4 (0.5)	1.4	342-528	1.4	1.8	3	140M-C2E-B25	100-C07	35
22B-D2P3x104	0.75 (1.0)	2.3	342-528	2.3	3.2	6	140M-C2E-B40	100-C07	50
22B-D4P0x104	1.5 (2.0)	4.0	342-528	4.0	5.7	10	140M-C2E-B63	100-C09	70
22B-D6P0x104	2.2 (3.0)	6.0	342-528	5.9	7.5	15	140M-C2E-C10	100-C09	100
22B-D010x104	4.0 (5.0)	10.5	342-528	10.3	13.0	20	140M-C2E-C16	100-C23	160
22B-D012x104	5.5 (7.5)	12.0	342-528	11.8	14.2	25	140M-D8E-C20	100-C23	175
22B-D017x104	7.5 (10.0)	17.0	342-528	16.8	18.4	30	140M-D8E-C20	100-C23	210
22B-D024x104	11.0 (15.0)	24.0	342-528	23.4	26.0	50	140M-F8E-C32	100-C43	300
460 - 600V AC (±10%) – 3-Phase Input, 0 - 575V 3-Phase Output									
22B-E1P7x104	0.75 (1.0)	1.7	414-660	2.1	2.3	6	140M-C2E-B25	100-C09	50
22B-E3P0x104	1.5 (2.0)	3.0	414-660	3.65	3.8	6	140M-C2E-B40	100-C09	70
22B-E4P2x104	2.2 (3.0)	4.2	414-660	5.2	5.3	10	140M-C2E-B63	100-C09	100
22B-E6P6x104	4.0 (5.0)	6.6	414-660	8.1	8.3	15	140M-C2E-C10	100-C09	160
22B-E9P9x104	5.5 (7.5)	9.9	414-660	12.1	11.2	20	140M-C2E-C16	100-C16	175
22B-E012x104	7.5 (10.0)	12.2	414-660	14.9	13.7	25	140M-C2E-C16	100-C23	210
22B-E019x104	11.0 (15.0)	19.0	414-660	23.1	24.1	40	140M-D8E-C25	100-C30	300

(1) In the Catalog Numbers listed "x" represents enclosure type. Specifications are valid for all enclosure types. IP66, NEMA/UL Type 4X drive ratings are only available as Frame B drives.

(2) 200-240V AC - 1-Phase drives are also available with an integral EMC filter. Catalog suffix changes from N104 to N114. Filter option is not available for IP66, NEMA/UL Type 4X rated drives.

Input/Output Ratings		Approvals	
<i>Output Frequency:</i> 0-400 Hz (Programmable) <i>Efficiency:</i> 97.5% (Typical)			
Digital Control Inputs (Input Current = 6mA)		Analog Control Inputs	
SRC (Source) Mode: 18-24V = ON 0-6V = OFF	SNK (Sink) Mode: 0-6V = ON 18-24V = OFF	<i>4-20mA Analog:</i> 250 ohm input impedance <i>0-10V DC Analog:</i> 100k ohm input impedance <i>External Pot:</i> 1-10k ohms, 2 Watt minimum	
Control Output			
<i>Programmable Output (form C relay)</i> Resistive Rating: 3.0A at 30V DC, 3.0A at 125V AC, 3.0A at 240V AC Inductive Rating: 0.5A at 30V DC, 0.5A at 125V AC, 0.5A at 240V AC		<i>Opto Outputs</i> 30V DC, 50mA Non-inductive	<i>Analog Outputs (10 bit)</i> 0-10V, 1k ohm Min. 4-20mA, 525 ohm Max.
Fuses and Circuit Breakers			
<i>Recommended Fuse Type:</i> UL Class J, CC, T or Type BS88; 600V (550V) or equivalent. <i>Recommended Circuit Breakers:</i> HMCP circuit breakers or equivalent.			
Protective Features			
<i>Motor Protection:</i> I ² t overload protection - 150% for 60 Secs, 200% for 3 Secs (Provides Class 10 protection)			
<i>Overcurrent:</i> 200% hardware limit, 300% instantaneous fault			
<i>Over Voltage:</i> 100-120V AC Input – Trip occurs at 405V DC bus voltage (equivalent to 150V AC incoming line) 200-240V AC Input – Trip occurs at 405V DC bus voltage (equivalent to 290V AC incoming line) 380-460V AC Input – Trip occurs at 810V DC bus voltage (equivalent to 575V AC incoming line) 460-600V AC Input – Trip occurs at 1005V DC bus voltage (equivalent to 711V AC incoming line)			
<i>Under Voltage:</i> 100-120V AC Input – Trip occurs at 210V DC bus voltage (equivalent to 75V AC incoming line) 200-240V AC Input – Trip occurs at 210V DC bus voltage (equivalent to 150V AC incoming line) 380-480V AC Input – Trip occurs at 390V DC bus voltage (equivalent to 275V AC incoming line) 460-600V AC Input – If P042 = 3 "High Voltage" trip occurs at 487V DC bus voltage (344V AC incoming line); If P042 = 2 "Low Voltage" trip occurs at 390V DC bus voltage (275V AC incoming line)			
<i>Control Ride Through:</i> Minimum ride through is 0.5 Secs - typical value 2 Secs			
<i>Faultless Power Ride Through:</i> 100 milliseconds			
Dynamic Braking			
Internal brake IGBT included with all ratings except No Brake versions. Refer to Appendix B of the PowerFlex 40 <i>User Manual</i> for DB resistor ordering information.			

Power Wiring

Power Wire Rating	Recommended Copper Wire
Unshielded 600V, 75°C (167°F) THHN/THWN	15 Mils insulated, dry location
Shielded 600V, 75°C or 90°C (167°F or 194°F) RHH/RHW-2	Anixter OLF-7xxxxx, Belden 29501-29507 or equivalent
Shielded Tray rated 600V, 75°C or 90°C (167°F or 194°F) RHH/RHW-2	Anixter 7V-7xxxx-3G Shawflex 2ACD/3ACD or equivalent

Power Terminal Block

B Frame

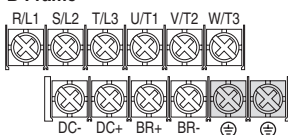

C Frame

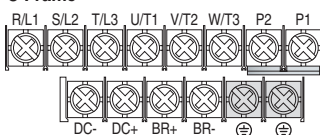

Terminal ⁽¹⁾	Description
R/L1, S/L2	1-Phase Input
R/L1, S/L2, T/L3	3-Phase Input
U/T1	To Motor U/T1
V/T2	To Motor V/T2
W/T3	To Motor W/T3
P2, P1	DC Bus Inductor Connection (C Frame drives only) The C Frame drive is shipped with a jumper between Terminals P2 and P1. Remove this jumper only when a DC Bus Inductor will be connected. Drive will not power up without a jumper or inductor connected. 
DC+, DC-	DC Bus Connection
BR+, BR-	Dynamic Brake Resistor Connection
⊖	Safety Ground - PE



Switch any two motor leads to change forward direction.

⁽¹⁾ **Important:** Terminal screws may become loose during shipment. Ensure that all terminal screws are tightened to the recommended torque before applying power to the drive.

Power Terminal Block Specifications

Frame	Maximum Wire Size ⁽²⁾	Minimum Wire Size ⁽²⁾	Torque
B	5.3 mm ² (10 AWG)	1.3 mm ² (16 AWG)	1.7-2.2 N-m (16-19 lb.-in.)
C	8.4 mm ² (8 AWG)	1.3 mm ² (16 AWG)	2.9-3.7 N-m (26-33 lb.-in.)

⁽²⁾ Maximum/minimum sizes that the terminal block will accept - these are not recommendations.

Input Power Conditions

Input Power Condition	Corrective Action
Low Line Impedance (less than 1% line reactance)	<ul style="list-style-type: none"> • Install Line Reactor⁽²⁾ • or Isolation Transformer • or Bus Inductor – 5.5-11 kW (7.5-15 HP) drives only
Greater than 120 kVA supply transformer	
Line has power factor correction capacitors	<ul style="list-style-type: none"> • Install Line Reactor • or Isolation Transformer
Line has frequent power interruptions	
Line has intermittent noise spikes in excess of 6000V (lightning)	
Phase to ground voltage exceeds 125% of normal line to line voltage	<ul style="list-style-type: none"> • Remove MOV jumper to ground. • or Install Isolation Transformer with grounded secondary if necessary.
Ungrounded distribution system	
240V open delta configuration (stinger leg) ⁽¹⁾	<ul style="list-style-type: none"> • Install Line Reactor

(1) For drives applied on an open delta with a middle phase grounded neutral system, the phase opposite the phase that is tapped in the middle to the neutral or earth is referred to as the “stinger leg,” “high leg,” “red leg,” etc. This leg should be identified throughout the system with red or orange tape on the wire at each connection point. The stinger leg should be connected to the center Phase B on the reactor. Refer to the PowerFlex 40 *User Manual* for specific line reactor part numbers.

(2) Refer to Appendix B of the PowerFlex 40 *User Manual* for accessory ordering information.

I/O Wiring Recommendations⁽³⁾

Wire Type(s) ⁽⁴⁾	Description	Minimum Insulation Rating
Belden 8760/9460 (or equiv.)	0.8 mm ² (18AWG), twisted pair, 100% shield with drain.	300V 60 degrees C (140 degrees F)
Belden 8770 (or equiv.)	0.8 mm ² (18AWG), 3 conductor, shielded for remote pot only.	

(3) If the wires are short and contained within a cabinet which has no sensitive circuits, the use of shielded wire may not be necessary, but is always recommended.

(4) Stranded or solid wire.

I/O Terminal Block Specifications

Frame	Maximum Wire Size ⁽⁵⁾	Minimum Wire Size ⁽⁵⁾	Torque
B & C	1.3 mm ² (16 AWG)	0.2 mm ² (24 AWG)	0.5-0.8 N-m (4.4-7 lb.-in.)

(5) Maximum / minimum that the terminal block will accept - these are not recommendations.

Refer to the PowerFlex 40 *User Manual* for recommendations on maximum power and control cable length.

Control Terminal Block

Control Wiring Block Diagram

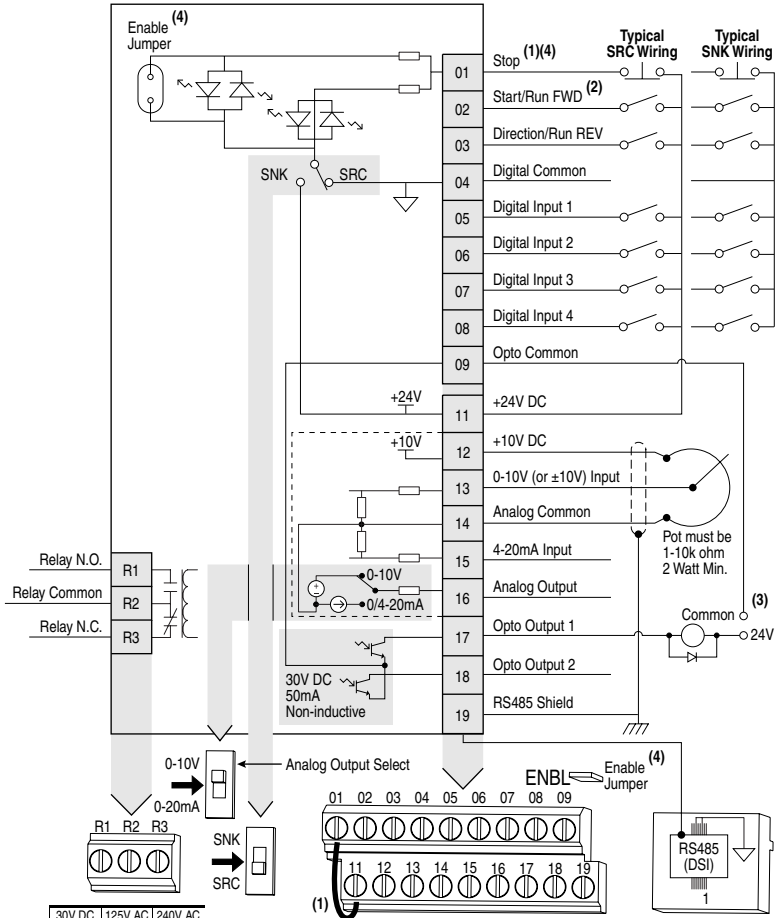

	30V DC	125V AC	240V AC
Resistive	3.0A	3.0A	3.0A
Inductive	0.5A	0.5A	0.5A

P036 [Start Source]	Stop	I/O Terminal 01 Stop
Keypad	Per P037	Coast
3-Wire	Per P037	Per P037
2-Wire	Per P037	Coast
RS485 Port	Per P037	Coast

(1) **Important:** I/O Terminal 01 is always a coast to stop input except when P036 [Start Source] is set to "3-Wire" or "Momt FWD/REV" control. In three wire control, I/O Terminal 01 is controlled by P037 [Stop Mode]. All other stop sources are controlled by P037 [Stop Mode].

Important: The drive is shipped with a jumper installed between I/O Terminals 01 and 11. Remove this jumper when using I/O Terminal 01 as a stop or enable input.

- (2) Two wire control shown. For three wire control use a momentary input $\text{---} \text{---} \text{---}$ on I/O Terminal 02 to command a start. Use a maintained input $\text{---} \text{---} \text{---}$ for I/O Terminal 03 to change direction.
- (3) When using an opto output with an inductive load such as a relay, install a recovery diode parallel to the relay as shown, to prevent damage to the output.
- (4) When the ENBL jumper is removed, I/O Terminal 01 will always act as a hardware enable, causing a coast to stop without software interpretation. Refer to the PowerFlex 40 User Manual for more information.

Control I/O Terminal Designations

No.	Signal	Default	Description	Param.
R1	Relay N.O.	Fault	Normally open contact for output relay.	A055
R2	Relay Common	–	Common for output relay.	
R3	Relay N.C.	Fault	Normally closed contact for output relay.	A055
Analog Output Select DIP Switch		0-10V	Sets analog output to either voltage or current. Setting must match A065 [Analog Out Sel].	
Sink/Source DIP Switch		Source (SRC)	Inputs can be wired as Sink (SNK) or Source (SRC) via DIP Switch setting.	
01	Stop ⁽¹⁾	Coast	The factory installed jumper or a normally closed input must be present for the drive to start.	P036 ⁽¹⁾
02	Start/Run FWD	Not Active	Command comes from the integral keypad by default.	P036, P037
03	Direction/Run REV	Not Active	To disable reverse operation, see A095 [Reverse Disable].	P036, P037, A095
04	Digital Common	–	For digital inputs. Electronically isolated with digital inputs from analog I/O and opto outputs.	
05	Digital Input 1	Preset Freq	Program with A051 [Digital In1 Sel].	A051
06	Digital Input 2	Preset Freq	Program with A052 [Digital In2 Sel].	A052
07	Digital Input 3	Local	Program with A053 [Digital In3 Sel].	A053
08	Digital Input 4	Jog Forward	Program with A054 [Digital In4 Sel].	A054
09	Opto Common	–	For opto-coupled outputs. Electronically isolated with opto outputs from analog I/O and digital inputs.	
11	+24V DC	–	Referenced to Digital Common. Drive supplied power for digital inputs. Maximum output current is 100mA.	
12	+10V DC	–	Referenced to Analog Common. Drive supplied power for 0-10V external potentiometer. Maximum output current is 15mA.	P038
13	±10V In ⁽²⁾	Not Active	For external 0-10V (unipolar) or ±10V (bipolar) input supply (input impedance = 100k ohm) or potentiometer wiper.	P038, A051-A054, A123, A132
14	Analog Common	–	For 0-10V In or 4-20mA In. Electronically isolated with analog inputs and outputs from digital I/O and opto outputs.	
15	4-20mA In ⁽²⁾	Not Active	For external 4-20mA input supply (input impedance = 250 ohm).	P038, A051-A054, A132
16	Analog Output	OutFreq 0-10	The default analog output is 0-10V. To convert to a current value, change the Analog Output Select DIP Switch to 0-20mA. Program with A065 [Analog Out Sel]. Max analog value can be scaled with A066 [Analog Out High]. Maximum Load: 4-20mA = 525 ohm (10.5V) 0-10V = 1k ohm (10mA)	A065, A066
17	Opto Output 1	MotorRunning	Program with A058 [Opto Out1 Sel]	A058, A059, A064
18	Opto Output 2	At Frequency	Program with A061 [Opto Out2 Sel]	A061, A062, A064
19	RS485 (DSI) Shield	–	Terminal should be connected to safety ground - PE when using the RS485 (DSI) communications port.	

(1) See Footnotes (1) and (4) on page 8.

(2) 0-10V In and 4-20mA In are distinct input channels and may be connected simultaneously. Inputs may be used independently for speed control or jointly when operating in PID mode.

Prepare For Drive Start-Up



ATTENTION: Power must be applied to the drive to perform the following start-up procedures. Some of the voltages present are at incoming line potential. To avoid electric shock hazard or damage to equipment, only qualified service personnel should perform the following procedure. Thoroughly read and understand the procedure before beginning. If an event does not occur while performing this procedure, **Do Not Proceed. Remove All Power** including user supplied control voltages. User supplied voltages may exist even when main AC power is not applied to the drive. Correct the malfunction before continuing.

Before Applying Power to the Drive

- 1. Confirm that all inputs are connected to the correct terminals and are secure.
- 2. Verify that AC line power at the disconnect device is within the rated value of the drive.
- 3. Verify that any digital control power is 24 volts.
- 4. Verify that the Sink (SNK)/Source (SRC) Setup DIP Switch is set to match your control wiring scheme. See page 8 for location.

Important: The default control scheme is Source (SRC). The Stop terminal is jumpered (I/O Terminals 01 and 11) to allow starting from the keypad. If the control scheme is changed to Sink (SNK), the jumper must be removed from I/O Terminals 01 and 11 and installed between I/O Terminals 01 and 04.

- 5. Verify that the Stop input is present or the drive will not start.

Important: If I/O Terminal 01 is used as a stop input, the jumper between I/O Terminals 01 and 11 must be removed.

Applying Power to the Drive

- 6. Apply AC power and control voltages to the drive.
- 7. Familiarize yourself with the integral keypad features (see next page) before setting any Program Group parameters.

If a fault appears on power up, refer to page 20 for an explanation of the fault code. For complete troubleshooting information, refer to the *PowerFlex 40 User Manual*.

Start, Stop, Direction and Speed Control

Factory default parameter values allow the drive to be controlled from the integral keypad. No programming is required to start, stop, change direction and control speed directly from the integral keypad.

Important: To disable reverse operation, see A095 [Reverse Disable].

Changing the Speed Reference of an IP66, NEMA/UL Type 4X rated drive

When a Display Group parameter, for example, d001 [Output Freq] is displayed, and P038 [Speed Ref] is set to A069 [Internal Freq], you can change the internal frequency using the Up Arrow and Down Arrow keys.

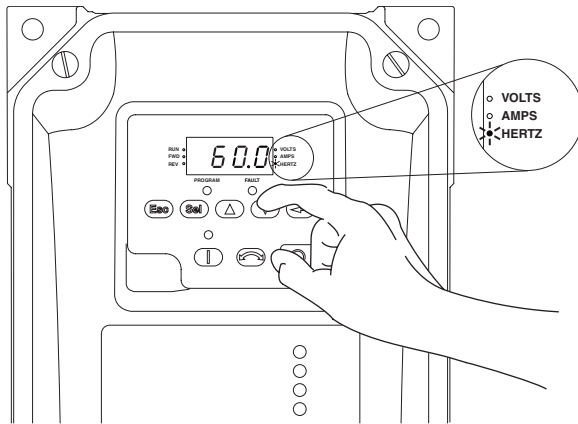

When the internal frequency is being adjusted, its value is displayed and the Hertz LED flashes. Any changes are saved immediately. The display then returns to the Display Group parameter previously shown.

TIP: By default, the speed reference of an IP66, NEMA/UL Type 4X rated drive is set to the internal frequency, A069 [Internal Freq].

TIP: You can also change the speed reference by editing the parameter A069 [Internal Freq] in program mode. For details on how to enter the program mode, see the section, “Viewing and Editing Parameters.”

The default value of A069 [Internal Freq] is 0 Hz. For IP20 rated PowerFlex 40 drives, the default value of this parameter is 60 Hz.

Integral Keypad

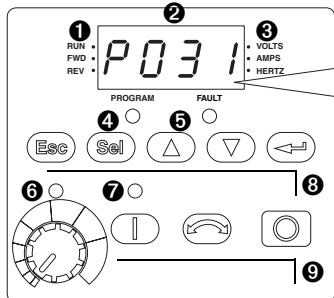

Menu	Description
d	Display Group (View Only) Consists of commonly viewed drive operating conditions.
P	Basic Program Group Consists of most commonly used programmable functions.
A	Advanced Program Group Consists of remaining programmable functions.
F	Fault Designator Consists of list of codes for specific fault conditions. Displayed only when fault is present.

No.	LED	LED State	Description
1	Run/Direction Status	Steady Red	Indicates drive is running and commanded motor direction.
		Flashing Red	Drive has been commanded to change direction. Indicates actual motor direction while decelerating to zero.
2	Alphanumeric Display	Steady Red	Indicates parameter number, parameter value, or fault code.
		Flashing Red	Single digit flashing indicates that digit can be edited. All digits flashing indicates a fault condition.
3	Displayed Units	Steady Red	Indicates the units of the parameter value being displayed.
4	Program Status	Steady Red	Indicates parameter value can be changed.
5	Fault Status	Flashing Red	Indicates drive is faulted.
6	Pot Status	Steady Green	Indicates potentiometer on Integral Keypad is active. ⁽¹⁾
7	Start Key Status	Steady Green	Indicates Start key on Integral Keypad is active. The Reverse key is also active unless disabled by A095 [Reverse Disable].























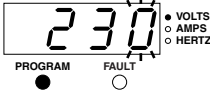



No.	Key	Name	Description
8		Escape	Back one step in programming menu. Cancel a change to a parameter value and exit Program Mode.
		Select	Advance one step in programming menu. Select a digit when viewing parameter value.
		Up Arrow Down Arrow	Scroll through groups and parameters. Increase/decrease the value of a flashing digit. Used to adjust internal frequency of IP66, NEMA/UL Type 4X rated drives <i>only</i> when a Display Group parameter is shown and P038 [Speed Reference] is set to internal frequency, A069 [Internal Freq].
		Enter	Advance one step in programming menu. Save a change to a parameter value.
9		Potentiometer ⁽¹⁾	Used to control speed of drive. Default is active. Controlled by parameter P038 [Speed Reference].
		Start	Used to start the drive. Default is active. Controlled by parameter P036 [Start Source].
		Reverse	Used to reverse direction of the drive. Default is active. Controlled by parameters P036 [Start Source] and A095 [Reverse Disable].
		Stop	Used to stop the drive or clear a fault. This key is always active. Controlled by parameter P037 [Stop Mode].

⁽¹⁾ IP66, NEMA/UL Type 4X rated drives are not equipped with a potentiometer.

Viewing and Editing Parameters

The last user-selected Display Group parameter is saved when power is removed and is displayed by default when power is reapplied.

The following is an example of basic integral keypad and display functions. This example provides basic navigation instructions and illustrates how to program the first Program Group parameter.

Step	Key(s)	Example Displays
1. When power is applied, the last user-selected Display Group parameter number is briefly displayed with flashing characters. The display then defaults to that parameter's current value. (Example shows the value of d001 [Output Freq] with the drive stopped.)		
2. Press Esc once to display the Display Group parameter number shown on power-up. The parameter number will flash.		
3. Press Esc again to enter the group menu. The group menu letter will flash.		
4. Press the Up Arrow or Down Arrow to scroll through the group menu (d, P and A).	 or 	
5. Press Enter or Sel to enter a group. The right digit of the last viewed parameter in that group will flash.	 or 	
6. Press the Up Arrow or Down Arrow to scroll through the parameters that are in the group.	 or 	
7. Press Enter or Sel to view the value of a parameter. If you do not want to edit the value, press Esc to return to the parameter number.	 or 	
8. Press Enter or Sel to enter program mode to edit the parameter value. The right digit will flash and the Program LED will illuminate if the parameter can be edited.	 or 	
9. Press the Up Arrow or Down Arrow to change the parameter value. If desired, press Sel to move from digit to digit or bit to bit. The digit or bit that you can change will flash.	 or 	
10. Press Esc to cancel a change. The digit will stop flashing, the previous value is restored and the Program LED will turn off.		
Or		
Press Enter to save a change. The digit will stop flashing and the Program LED will turn off.		
11. Press Esc to return to the parameter list. Continue to press Esc to back out of the programming menu. If pressing Esc does not change the display, then d001 [Output Frequency] is displayed. Press Enter or Sel to enter the group menu.		

The Basic Program Group contains the most commonly changed parameters.

Display Group Parameters

No.	Parameter	Min/Max	Display/Options
d001	[Output Freq]	0.0/[Maximum Freq]	0.1 Hz
d002	[Commanded Freq]	0.0/[Maximum Freq]	0.1 Hz
d003	[Output Current]	0.00/(Drive Amps × 2)	0.01 Amps
d004	[Output Voltage]	0/Drive Rated Volts	1 VAC
d005	[DC Bus Voltage]	Based on Drive Rating	1 VDC
d006	[Drive Status]	0/1 (1 = Condition True)	Bit 3 Decelerating Bit 2 Accelerating Bit 1 Forward Bit 0 Running
d007-d009	[Fault x Code]	F2/F122	F1
d010	[Process Display]	0.00/9999	0.01 – 1
d012	[Control Source]	0/9	Digit 1 = Speed Command (See P038; 9 = "Jog Freq") Digit 0 = Start Command (See P036; 9 = "Jog")
d013	[Contrl In Status]	0/1 (1 = Input Present)	Bit 3 DB Trans On Bit 2 Stop Input Bit 1 Dir/REV In Bit 0 Start/FWD In
d014	[Dig In Status]	0/1 (1 = Input Present)	Bit 3 Digital In 4 Bit 2 Digital In 3 Bit 1 Digital In 2 Bit 0 Digital In 1
d015	[Comm Status]	0/1 (1 = Condition True)	Bit 3 Comm Error Bit 2 DSI Option Bit 1 Transmitting Bit 0 Receiving
d016	[Control SW Ver]	1.00/99.99	0.01
d017	[Drive Type]	1001/9999	1
d018	[Elapsed Run Time]	0/9999 Hrs	1 = 10 Hrs
d019	[Testpoint Data]	0/FFFF	1 Hex
d020	[Analog In 0-10V]	0.0/100.0%	0.1%
d021	[Analog In 4-20mA]	0.0/100.0%	0.1%
d022	[Output Power]	0.00/(Drive Power × 2)	0.01 kW
d023	[Output Powr Fctr]	0.0/180.0 deg	0.1 deg
d024	[Drive Temp]	0/120 degC	1 degC
d025	[Counter Status]	0/9999	1
d026	[Timer Status]	0.0/9999 Secs	0.1 Secs
d028	[Stp Logic Status]	0/7	1
d029	[Torque Current]	0.00/(Drive Amps × 2)	0.01 Amps

Smart Start-Up with Basic Program Group Parameters

The PowerFlex 40 is designed so that start up is simple and efficient. The Program Group contains the most commonly used parameters.

= Stop drive before changing this parameter.

No.	Parameter	Min/Max	Display/Options	Default
P031	[Motor NP Volts] <input type="radio"/> Set to the motor nameplate rated volts.	20/Drive Rated Volts	1 VAC	Based on Drive Rating
P032	[Motor NP Hertz] <input type="radio"/> Set to the motor nameplate rated frequency.	15/400 Hz	1 Hz	60 Hz
P033	[Motor OL Current] Set to the maximum allowable motor current.	0.0/(Drive Rated Amps×2)	0.1 Amps	Based on Drive Rating
P034	[Minimum Freq] Sets the lowest frequency the drive will output continuously.	0.0/400.0 Hz	0.1 Hz	0.0 Hz
P035	[Maximum Freq] <input type="radio"/> Sets the highest frequency the drive will output.	0/400 Hz	1 Hz	60 Hz
P036	[Start Source] <input type="radio"/> Sets the control scheme used to start the drive. (1) When active, the Reverse key is also active unless disabled by A095 [Reverse Disable].	0/6	0 = "Keypad"(1) 1 = "3-Wire" 2 = "2-Wire" 3 = "2-W Lvl Sens" 4 = "2-W Hi Speed" 5 = "Comm Port" 6 = "Momt FWD/REV"	0

= Stop drive before changing this parameter.

No.	Parameter	Min/Max	Display/Options	Default
P037	[Stop Mode] Active stop mode for all stop sources [e.g. keypad, run forward (I/O Terminal 02), run reverse (I/O Terminal 03), RS485 port] except as noted below. Important: I/O Terminal 01 is always a coast to stop input except when P036 [Start Source] is set for "3-Wire" control. When in three wire control, I/O Terminal 01 is controlled by P037 [Stop Mode].	0/9	0 = "Ramp, CF" ⁽¹⁾ 1 = "Coast, CF" ⁽¹⁾ 2 = "DC Brake, CF" ⁽¹⁾ 3 = "DCBrkAuto, CF" ⁽¹⁾ 4 = "Ramp" 5 = "Coast" 6 = "DC Brake" 7 = "DC BrakeAuto" 8 = "Ramp+EM B, CF" 9 = "Ramp+EM Brk" ⁽¹⁾ Stop input also clears active fault.	0
P038	[Speed Reference] Sets the source of the speed reference to the drive. Important: When A051 or A052 [Digital Inx Sel] is set to option 2, 4, 5, 6, 13 or 14 and the digital input is active, A051, A052, A053 or A054 will override the speed reference commanded by this parameter. Refer to Chapter 1 of the PowerFlex 40 User Manual for details.	0/7	0 = "Drive Pot" 1 = "Internal Freq" 2 = "0-10V Input" 3 = "4-20mA Input" 4 = "Preset Freq" 5 = "Comm Port" 6 = "Stp Logic" 7 = "Anlg In Mult"	0 1 (IP66, Type 4X)
P039	[Accel Time 1] Sets the rate of accel for all speed increases.	0.0/600.0 Secs	0.1 Secs	10.0 Secs
P040	[Decel Time 1] Sets the rate of decel for all speed decreases.	0.1/600.0 Secs	0.1 Secs	10.0 Secs
P041	[Reset To Defaults] <input type="radio"/> Resets all parameter values to factory defaults.	0/1	0 = "Ready/Idle" 1 = "Factory Rset"	0
P042	[Voltage Class] <input type="radio"/> Sets the voltage class of 600V drives.	2/3	2 = "Low Voltage" (480V) 3 = "High Voltage" (600V)	3
P043	[Motor OL Ret] Enables/disables the Motor Overload Retention function.	0/1	0 = "Disabled" 1 = "Enabled"	0

Advanced Group Parameters

No.	Parameter	Min/Max	Display/Options	Default																				
A051	[Digital In1 Sel] I/O Terminal 05	0/27	0 = "Not Used" 14 = "20mA In Ctrl" 1 = "Acc & Dec 2" 15 = "PID Disable" 2 = "Jog" 16 = "MOP Up" 3 = "Aux Fault" 17 = "MOP Down" 4 = "Preset Freq" 18 = "Timer Start" 5 = "Local"(1) 19 = "Counter In" 6 = "Comm Port" 20 = "Reset Timer" 7 = "Clear Fault" 21 = "Reset Count" 8 = "RampStop,CF" 22 = "Rset Tim&Cnt" 9 = "CoastStop,CF" 23 = "Logic In1" 10 = "DCInjStop,CF" 24 = "Logic In2" 11 = "Jog Forward" 25 = "Current Lmt2" 12 = "Jog Reverse" 26 = "Anlg Invert" 13 = "10V In Ctrl" 27 = "EM Brk Rise"	4																				
A052	[Digital In2 Sel] I/O Terminal 06			4																				
A053	[Digital In3 Sel] I/O Terminal 07			5																				
A054	[Digital In4 Sel] I/O Terminal 08			11																				
	(1) Important: Speed source for IP66, NEMA/UL Type 4X rated drives comes from A069 [Internal Freq].																							
A055	[Relay Out Sel]	0/24	0 = "Ready/Fault" 13 = "Logic 1 & 2" 1 = "At Frequency" 14 = "Logic 1 or 2" 2 = "MotorRunning" 15 = "StpLogic Out" 3 = "Reverse" 16 = "Timer Out" 4 = "Motor Overld" 17 = "Counter Out" 5 = "Ramp Reg" 18 = "Above PF Ang" 6 = "Above Freq" 19 = "Anlg In Loss" 7 = "Above Cur" 20 = "ParamControl" 8 = "Above DCVolt" 21 = "NonRec Fault" 9 = "Retries Exst" 22 = "EM Brk Cntrl" 10 = "Above Anlg V" 23 = "Above Fcmd" 11 = "Logic In 1" 24 = "MsgControl" (for 12 = "Logic In 2" FRN 6.01 and later)	0																				
A056	[Relay Out Level]	0.0/9999	0.1	0.0																				
A058 A061	[Opto Out1 Sel] [Opto Out2 Sel]	0/24	See A055 for Options.	2 1																				
A059 A062	[Opto Out1 Level] [Opto Out2 Level]	0.0/9999	0.1	0.0																				
	<table border="1" style="width: 100%; border-collapse: collapse;"> <thead> <tr> <th style="text-align: left;">A055, A058 & A061 Setting</th> <th style="text-align: left;">A056, A059 & A062 Min/Max</th> </tr> </thead> <tbody> <tr><td>6</td><td>0/400 Hz</td></tr> <tr><td>7</td><td>0/180%</td></tr> <tr><td>8</td><td>0/815 Volts</td></tr> <tr><td>10</td><td>0/100%</td></tr> <tr><td>16</td><td>0.1/9999 Secs</td></tr> <tr><td>17</td><td>1/9999 Counts</td></tr> <tr><td>18</td><td>1/180 degs</td></tr> <tr><td>20</td><td>0/1</td></tr> <tr><td>23</td><td>0/400 Hz</td></tr> </tbody> </table>	A055, A058 & A061 Setting	A056, A059 & A062 Min/Max	6	0/400 Hz	7	0/180%	8	0/815 Volts	10	0/100%	16	0.1/9999 Secs	17	1/9999 Counts	18	1/180 degs	20	0/1	23	0/400 Hz			
A055, A058 & A061 Setting	A056, A059 & A062 Min/Max																							
6	0/400 Hz																							
7	0/180%																							
8	0/815 Volts																							
10	0/100%																							
16	0.1/9999 Secs																							
17	1/9999 Counts																							
18	1/180 degs																							
20	0/1																							
23	0/400 Hz																							
A064	[Opto Out Logic]	0/3	1	0																				
	<table border="1" style="width: 100%; border-collapse: collapse;"> <thead> <tr> <th style="text-align: left;">A064 Option</th> <th style="text-align: left;">Opto Out1 Logic</th> <th style="text-align: left;">Opto Out2 Logic</th> </tr> </thead> <tbody> <tr><td>0</td><td>NO (Normally Open)</td><td>NO (Normally Open)</td></tr> <tr><td>1</td><td>NC (Normally Closed)</td><td>NO (Normally Open)</td></tr> <tr><td>2</td><td>NO (Normally Open)</td><td>NC (Normally Closed)</td></tr> <tr><td>3</td><td>NC (Normally Closed)</td><td>NC (Normally Closed)</td></tr> </tbody> </table>	A064 Option	Opto Out1 Logic	Opto Out2 Logic	0	NO (Normally Open)	NO (Normally Open)	1	NC (Normally Closed)	NO (Normally Open)	2	NO (Normally Open)	NC (Normally Closed)	3	NC (Normally Closed)	NC (Normally Closed)								
A064 Option	Opto Out1 Logic	Opto Out2 Logic																						
0	NO (Normally Open)	NO (Normally Open)																						
1	NC (Normally Closed)	NO (Normally Open)																						
2	NO (Normally Open)	NC (Normally Closed)																						
3	NC (Normally Closed)	NC (Normally Closed)																						

No.	Parameter	Min/Max	Display/Options	Default																																																																																																																												
A065	[Analog Out Sel]	0/23	1	0																																																																																																																												
	<table border="1"> <thead> <tr> <th>Option</th> <th>Output Range</th> <th>Minimum Output Value</th> <th>Maximum Output Value [Analog Out High]</th> <th>DIP Switch Position</th> </tr> </thead> <tbody> <tr><td>0 "OutFreq 0-10"</td><td>0-10V</td><td>0V = 0 Hz</td><td>P035 [Maximum Freq]</td><td>0-10V</td></tr> <tr><td>1 "OutCurr 0-10"</td><td>0-10V</td><td>0V = 0 Amps</td><td>200% Drive Rated FLA</td><td>0-10V</td></tr> <tr><td>2 "OutVolt 0-10"</td><td>0-10V</td><td>0V = 0 Volts</td><td>120% Drive Rated Output Volts</td><td>0-10V</td></tr> <tr><td>3 "OutPowr 0-10"</td><td>0-10V</td><td>0V = 0 kW</td><td>200% Drive Rated Power</td><td>0-10V</td></tr> <tr><td>4 "TstData 0-10"</td><td>0-10V</td><td>0V = 0000</td><td>65535 (Hex FFFF)</td><td>0-10V</td></tr> <tr><td>5 "OutFreq 0-20"</td><td>0-20 mA</td><td>0 mA = 0 Hz</td><td>P035 [Maximum Freq]</td><td>0-20 mA</td></tr> <tr><td>6 "OutCurr 0-20"</td><td>0-20 mA</td><td>0 mA = 0 Amps</td><td>200% Drive Rated FLA</td><td>0-20 mA</td></tr> <tr><td>7 "OutVolt 0-20"</td><td>0-20 mA</td><td>0 mA = 0 Volts</td><td>120% Drive Rated Output Volts</td><td>0-20 mA</td></tr> <tr><td>8 "OutPowr 0-20"</td><td>0-20 mA</td><td>0 mA = 0 kW</td><td>200% Drive Rated Power</td><td>0-20 mA</td></tr> <tr><td>9 "TstData 0-20"</td><td>0-20 mA</td><td>0 mA = 0000</td><td>65535 (Hex FFFF)</td><td>0-20 mA</td></tr> <tr><td>10 "OutFreq 4-20"</td><td>4-20 mA</td><td>4 mA = 0 Hz</td><td>P035 [Maximum Freq]</td><td>0-20 mA</td></tr> <tr><td>11 "OutCurr 4-20"</td><td>4-20 mA</td><td>4 mA = 0 Amps</td><td>200% Drive Rated FLA</td><td>0-20 mA</td></tr> <tr><td>12 "OutVolt 4-20"</td><td>4-20 mA</td><td>4 mA = 0 Volts</td><td>120% Drive Rated Output Volts</td><td>0-20 mA</td></tr> <tr><td>13 "OutPowr 4-20"</td><td>4-20 mA</td><td>4 mA = 0 kW</td><td>200% Drive Rated Power</td><td>0-20 mA</td></tr> <tr><td>14 "TstData 4-20"</td><td>4-20 mA</td><td>4 mA = 0000</td><td>65535 (Hex FFFF)</td><td>0-20 mA</td></tr> <tr><td>15 "OutTorq 0-10"</td><td>0-10V</td><td>0V = 0 Amps</td><td>200% Drive Rated FLA</td><td>0-10V</td></tr> <tr><td>16 "OutTorq 0-20"</td><td>0-20 mA</td><td>0 mA = 0 Amps</td><td>200% Drive Rated FLA</td><td>0-20 mA</td></tr> <tr><td>17 "OutTorq 4-20"</td><td>4-20 mA</td><td>4 mA = 0 Amps</td><td>200% Drive Rated FLA</td><td>0-20 mA</td></tr> <tr><td>18 "Setpnt 0-10"</td><td>0-10V</td><td>0V = 0%</td><td>100.0% Setpoint Setting</td><td>0-10V</td></tr> <tr><td>19 "Setpnt 0-20"</td><td>0-20 mA</td><td>0 mA = 0%</td><td>100.0% Setpoint Setting</td><td>0-20 mA</td></tr> <tr><td>20 "Setpnt 4-20"</td><td>4-20 mA</td><td>4 mA = 0%</td><td>100.0% Setpoint Setting</td><td>0-20 mA</td></tr> <tr><td>21 "MinFreq 0-10"</td><td>0-10V</td><td>0V = Min. Freq</td><td>P035 [Maximum Freq]</td><td>0-10V</td></tr> <tr><td>22 "MinFreq 0-20"</td><td>0-20 mA</td><td>0 mA = Min. Freq</td><td>P035 [Maximum Freq]</td><td>0-20 mA</td></tr> <tr><td>23 "MinFreq 4-20"</td><td>4-20 mA</td><td>4 mA = Min. Freq</td><td>P035 [Maximum Freq]</td><td>0-20 mA</td></tr> </tbody> </table>	Option	Output Range	Minimum Output Value	Maximum Output Value [Analog Out High]	DIP Switch Position	0 "OutFreq 0-10"	0-10V	0V = 0 Hz	P035 [Maximum Freq]	0-10V	1 "OutCurr 0-10"	0-10V	0V = 0 Amps	200% Drive Rated FLA	0-10V	2 "OutVolt 0-10"	0-10V	0V = 0 Volts	120% Drive Rated Output Volts	0-10V	3 "OutPowr 0-10"	0-10V	0V = 0 kW	200% Drive Rated Power	0-10V	4 "TstData 0-10"	0-10V	0V = 0000	65535 (Hex FFFF)	0-10V	5 "OutFreq 0-20"	0-20 mA	0 mA = 0 Hz	P035 [Maximum Freq]	0-20 mA	6 "OutCurr 0-20"	0-20 mA	0 mA = 0 Amps	200% Drive Rated FLA	0-20 mA	7 "OutVolt 0-20"	0-20 mA	0 mA = 0 Volts	120% Drive Rated Output Volts	0-20 mA	8 "OutPowr 0-20"	0-20 mA	0 mA = 0 kW	200% Drive Rated Power	0-20 mA	9 "TstData 0-20"	0-20 mA	0 mA = 0000	65535 (Hex FFFF)	0-20 mA	10 "OutFreq 4-20"	4-20 mA	4 mA = 0 Hz	P035 [Maximum Freq]	0-20 mA	11 "OutCurr 4-20"	4-20 mA	4 mA = 0 Amps	200% Drive Rated FLA	0-20 mA	12 "OutVolt 4-20"	4-20 mA	4 mA = 0 Volts	120% Drive Rated Output Volts	0-20 mA	13 "OutPowr 4-20"	4-20 mA	4 mA = 0 kW	200% Drive Rated Power	0-20 mA	14 "TstData 4-20"	4-20 mA	4 mA = 0000	65535 (Hex FFFF)	0-20 mA	15 "OutTorq 0-10"	0-10V	0V = 0 Amps	200% Drive Rated FLA	0-10V	16 "OutTorq 0-20"	0-20 mA	0 mA = 0 Amps	200% Drive Rated FLA	0-20 mA	17 "OutTorq 4-20"	4-20 mA	4 mA = 0 Amps	200% Drive Rated FLA	0-20 mA	18 "Setpnt 0-10"	0-10V	0V = 0%	100.0% Setpoint Setting	0-10V	19 "Setpnt 0-20"	0-20 mA	0 mA = 0%	100.0% Setpoint Setting	0-20 mA	20 "Setpnt 4-20"	4-20 mA	4 mA = 0%	100.0% Setpoint Setting	0-20 mA	21 "MinFreq 0-10"	0-10V	0V = Min. Freq	P035 [Maximum Freq]	0-10V	22 "MinFreq 0-20"	0-20 mA	0 mA = Min. Freq	P035 [Maximum Freq]	0-20 mA	23 "MinFreq 4-20"	4-20 mA	4 mA = Min. Freq	P035 [Maximum Freq]	0-20 mA		
Option	Output Range	Minimum Output Value	Maximum Output Value [Analog Out High]	DIP Switch Position																																																																																																																												
0 "OutFreq 0-10"	0-10V	0V = 0 Hz	P035 [Maximum Freq]	0-10V																																																																																																																												
1 "OutCurr 0-10"	0-10V	0V = 0 Amps	200% Drive Rated FLA	0-10V																																																																																																																												
2 "OutVolt 0-10"	0-10V	0V = 0 Volts	120% Drive Rated Output Volts	0-10V																																																																																																																												
3 "OutPowr 0-10"	0-10V	0V = 0 kW	200% Drive Rated Power	0-10V																																																																																																																												
4 "TstData 0-10"	0-10V	0V = 0000	65535 (Hex FFFF)	0-10V																																																																																																																												
5 "OutFreq 0-20"	0-20 mA	0 mA = 0 Hz	P035 [Maximum Freq]	0-20 mA																																																																																																																												
6 "OutCurr 0-20"	0-20 mA	0 mA = 0 Amps	200% Drive Rated FLA	0-20 mA																																																																																																																												
7 "OutVolt 0-20"	0-20 mA	0 mA = 0 Volts	120% Drive Rated Output Volts	0-20 mA																																																																																																																												
8 "OutPowr 0-20"	0-20 mA	0 mA = 0 kW	200% Drive Rated Power	0-20 mA																																																																																																																												
9 "TstData 0-20"	0-20 mA	0 mA = 0000	65535 (Hex FFFF)	0-20 mA																																																																																																																												
10 "OutFreq 4-20"	4-20 mA	4 mA = 0 Hz	P035 [Maximum Freq]	0-20 mA																																																																																																																												
11 "OutCurr 4-20"	4-20 mA	4 mA = 0 Amps	200% Drive Rated FLA	0-20 mA																																																																																																																												
12 "OutVolt 4-20"	4-20 mA	4 mA = 0 Volts	120% Drive Rated Output Volts	0-20 mA																																																																																																																												
13 "OutPowr 4-20"	4-20 mA	4 mA = 0 kW	200% Drive Rated Power	0-20 mA																																																																																																																												
14 "TstData 4-20"	4-20 mA	4 mA = 0000	65535 (Hex FFFF)	0-20 mA																																																																																																																												
15 "OutTorq 0-10"	0-10V	0V = 0 Amps	200% Drive Rated FLA	0-10V																																																																																																																												
16 "OutTorq 0-20"	0-20 mA	0 mA = 0 Amps	200% Drive Rated FLA	0-20 mA																																																																																																																												
17 "OutTorq 4-20"	4-20 mA	4 mA = 0 Amps	200% Drive Rated FLA	0-20 mA																																																																																																																												
18 "Setpnt 0-10"	0-10V	0V = 0%	100.0% Setpoint Setting	0-10V																																																																																																																												
19 "Setpnt 0-20"	0-20 mA	0 mA = 0%	100.0% Setpoint Setting	0-20 mA																																																																																																																												
20 "Setpnt 4-20"	4-20 mA	4 mA = 0%	100.0% Setpoint Setting	0-20 mA																																																																																																																												
21 "MinFreq 0-10"	0-10V	0V = Min. Freq	P035 [Maximum Freq]	0-10V																																																																																																																												
22 "MinFreq 0-20"	0-20 mA	0 mA = Min. Freq	P035 [Maximum Freq]	0-20 mA																																																																																																																												
23 "MinFreq 4-20"	4-20 mA	4 mA = Min. Freq	P035 [Maximum Freq]	0-20 mA																																																																																																																												
A066	[Analog Out High]	0/800%	1%	100%																																																																																																																												
A067	[Accel Time 2]	0.0/600.0 Secs	0.1 Secs	20.0 Secs																																																																																																																												
A068	[Decel Time 2]	0.1/600.0 Secs	0.1 Secs	20.0 Secs																																																																																																																												
A069	[Internal Freq]	0.0/400.0 Hz	0.1 Hz	0.0 Hz (for IP66, NEMA/UL Type 4X drives) 60.0 Hz (for IP20 drives)																																																																																																																												
A070	[Preset Freq 0] ⁽¹⁾	0.0/400.0 Hz	0.1 Hz	0.0 Hz																																																																																																																												
A071	[Preset Freq 1]			5.0 Hz																																																																																																																												
A072	[Preset Freq 2]			10.0 Hz																																																																																																																												
A073	[Preset Freq 3]			20.0 Hz																																																																																																																												
A074	[Preset Freq 4]			30.0 Hz																																																																																																																												
A075	[Preset Freq 5]			40.0 Hz																																																																																																																												
A076	[Preset Freq 6]			50.0 Hz																																																																																																																												
A077	[Preset Freq 7]			60.0 Hz																																																																																																																												
	⁽¹⁾ To activate [Preset Freq 0] set P038 [Speed Reference] to option 4.																																																																																																																															
	<table border="1"> <thead> <tr> <th>Input State of Digital In 1 (I/O Terminal 05)</th> <th>Input State of Digital In 2 (I/O Terminal 06)</th> <th>Input State of Digital In 3 (I/O Terminal 07)</th> <th>Frequency Source</th> <th>Accel / Decel Parameter Used ⁽²⁾</th> </tr> </thead> <tbody> <tr><td>0</td><td>0</td><td>0</td><td>[Preset Freq 0]</td><td>[Accel Time 1] / [Decel Time 1]</td></tr> <tr><td>1</td><td>0</td><td>0</td><td>[Preset Freq 1]</td><td>[Accel Time 1] / [Decel Time 1]</td></tr> <tr><td>0</td><td>1</td><td>0</td><td>[Preset Freq 2]</td><td>[Accel Time 2] / [Decel Time 2]</td></tr> <tr><td>1</td><td>1</td><td>0</td><td>[Preset Freq 3]</td><td>[Accel Time 2] / [Decel Time 2]</td></tr> <tr><td>0</td><td>0</td><td>1</td><td>[Preset Freq 4]</td><td>[Accel Time 1] / [Decel Time 1]</td></tr> <tr><td>1</td><td>0</td><td>1</td><td>[Preset Freq 5]</td><td>[Accel Time 1] / [Decel Time 1]</td></tr> <tr><td>0</td><td>1</td><td>1</td><td>[Preset Freq 6]</td><td>[Accel Time 2] / [Decel Time 2]</td></tr> <tr><td>1</td><td>1</td><td>1</td><td>[Preset Freq 7]</td><td>[Accel Time 2] / [Decel Time 2]</td></tr> </tbody> </table>	Input State of Digital In 1 (I/O Terminal 05)	Input State of Digital In 2 (I/O Terminal 06)	Input State of Digital In 3 (I/O Terminal 07)	Frequency Source	Accel / Decel Parameter Used ⁽²⁾	0	0	0	[Preset Freq 0]	[Accel Time 1] / [Decel Time 1]	1	0	0	[Preset Freq 1]	[Accel Time 1] / [Decel Time 1]	0	1	0	[Preset Freq 2]	[Accel Time 2] / [Decel Time 2]	1	1	0	[Preset Freq 3]	[Accel Time 2] / [Decel Time 2]	0	0	1	[Preset Freq 4]	[Accel Time 1] / [Decel Time 1]	1	0	1	[Preset Freq 5]	[Accel Time 1] / [Decel Time 1]	0	1	1	[Preset Freq 6]	[Accel Time 2] / [Decel Time 2]	1	1	1	[Preset Freq 7]	[Accel Time 2] / [Decel Time 2]																																																																																		
Input State of Digital In 1 (I/O Terminal 05)	Input State of Digital In 2 (I/O Terminal 06)	Input State of Digital In 3 (I/O Terminal 07)	Frequency Source	Accel / Decel Parameter Used ⁽²⁾																																																																																																																												
0	0	0	[Preset Freq 0]	[Accel Time 1] / [Decel Time 1]																																																																																																																												
1	0	0	[Preset Freq 1]	[Accel Time 1] / [Decel Time 1]																																																																																																																												
0	1	0	[Preset Freq 2]	[Accel Time 2] / [Decel Time 2]																																																																																																																												
1	1	0	[Preset Freq 3]	[Accel Time 2] / [Decel Time 2]																																																																																																																												
0	0	1	[Preset Freq 4]	[Accel Time 1] / [Decel Time 1]																																																																																																																												
1	0	1	[Preset Freq 5]	[Accel Time 1] / [Decel Time 1]																																																																																																																												
0	1	1	[Preset Freq 6]	[Accel Time 2] / [Decel Time 2]																																																																																																																												
1	1	1	[Preset Freq 7]	[Accel Time 2] / [Decel Time 2]																																																																																																																												
	⁽²⁾ When a Digital Input is set to "Accel 2 & Decel 2", and the input is active, that input overrides the settings in this table.																																																																																																																															
A078	[Jog Frequency]	0.0/[Maximum Freq]	0.1 Hz	10.0 Hz																																																																																																																												
A079	[Jog Accel/Decel]	0.1/600.0 Secs	0.1 Secs	10.0 Secs																																																																																																																												
A080	[DC Brake Time] A setting of 99.9 Secs = Continuous	0.0/99.9 Secs	0.1 Secs	0.0 Secs																																																																																																																												
A081	[DC Brake Level]	0.0/(Drive Amps × 1.8)	0.1 Amps	Amps × 0.05																																																																																																																												
A082	[DB Resistor Sel]	0/99	0 = "Disabled" 1 = "Normal RA Res"	2 = "NoProtection" 3-99 = % of Duty Cycle																																																																																																																												
				0																																																																																																																												
A083	[S Curve %]	0/100%	1%	0% (Disabled)																																																																																																																												

No.	Parameter	Min/Max	Display/Options	Default
A084	[Boost Select] Only active when A125 [Torque Perf Mode] is set to 0 "V/Hz".	0/14	Settings in % of base voltage. 0 = "Custom V/Hz" <u>Variable Torque</u> 1 = "30.0, VT" 2 = "35.0, VT" 3 = "40.0, VT" 4 = "45.0, VT" <u>Constant Torque</u> 5 = "0.0, no IR" 6 = "0.0" 7 = "2.5, CT" 8 = "5.0, CT" 9 = "7.5, CT" 10 = "10.0, CT" 11 = "12.5, CT" 12 = "15.0, CT" 13 = "17.5, CT" 14 = "20.0, CT"	8 7 4-11 kW (5-15 HP)
A085	[Start Boost] Only active when A084 [Boost Select] and A125 [Torque Perf Mode] are set to "0".	0.0/25.0%	0.1%	2.5%
A086	[Break Voltage] Only active when A084 [Boost Select] and A125 [Torque Perf Mode] are set to "0".	0.0/100.0%	0.1%	25.0%
A087	[Break Frequency] Only active when A084 [Boost Select] and A125 [Torque Perf Mode] are set to "0".	0.0/400.0 Hz	0.1 Hz	15.0 Hz
A088	[Maximum Voltage]	20/Rated Volts	1 VAC	Rated Volts
A089	[Current Limit 1]	0.1/(Drive Amps × 1.8)	0.1 Amps	Amps × 1.5
A090	[Motor OL Select]	0/2	0 = "No Derate" 1 = "Min Derate" 2 = "Max Derate"	0
A091	[PWM Frequency]	2.0/16.0 kHz	0.1 kHz	4.0 kHz
A092	[Auto Rstrt Tries]	0/9	1	0
A093	[Auto Rstrt Delay]	0.0/300.0 Secs	0.1 Secs	1.0 Secs
A094	[Start At PowerUp] <input type="radio"/>	0/1	0 = "Disabled" 1 = "Enabled"	0
A095	[Reverse Disable] <input type="radio"/>	0/1	0 = "Rev Enabled" 1 = "Rev Disabled"	0
A096	[Flying Start En]	0/1	0 = "Disabled" 1 = "Enabled"	0
A097	[Compensation]	0/3	0 = "Disabled" 1 = "Electrical" 2 = "Mechanical" 3 = "Both"	1
A098	[SW Current Trip]	0.0/(Drive Amps × 2)	0.1 Amps	0.0 (Disabled)
A099	[Process Factor]	0.1/999.9	0.1	30.0
A100	[Fault Clear] <input type="radio"/>	0/2	0 = "Ready/Idle" 1 = "Reset Fault" 2 = "Clear Buffer"	0
A101	[Program Lock]	0/9999	0 = "Unlocked" 1 = "Locked"	0
A102	[Testpoint Sel]	400/FFFF	1 Hex	400
A103	[Comm Data Rate] Power to drive must be cycled before any changes will affect drive operation.	0/5	0 = "1200" 1 = "2400" 2 = "4800" 3 = "9600" 4 = "19.2K" 5 = "38.4K"	3
A104	[Comm Node Addr] Power to drive must be cycled before any changes will affect drive operation.	1/247	1	100
A105	[Comm Loss Action]	0/3	0 = "Fault" 1 = "Coast Stop" 2 = "Stop" 3 = "Continu Last"	0
A106	[Comm Loss Time]	0.1/60.0 Secs	0.1 Secs	5.0 Secs
A107	[Comm Format] Power to drive must be cycled before any changes will affect drive operation.	0/5	0 = "RTU 8-N-1" 1 = "RTU 8-E-1" 2 = "RTU 8-O-1" 3 = "RTU 8-N-2" 4 = "RTU 8-E-2" 5 = "RTU 8-O-2"	0
A108	[Language]	1/10	1 = "English" 2 = "Français" 3 = "Español" 4 = "Italiano" 5 = "Deutsch" 6 = "Reserved" 7 = "Portugués" 8 = "Reserved" 9 = "Reserved" 10 = "Nederlands"	1
A109	[Anlg Out Setpt]	0.0/100.0%	0.1%	0.0%
A110	[Anlg In 0-10V Lo] <input type="radio"/>	0.0/100.0%	0.1%	0.0%
A111	[Anlg In 0-10V Hi] <input type="radio"/>	0.0/100.0%	0.1%	100.0%
A112	[Anlg In4-20mA Lo] <input type="radio"/>	0.0/100.0%	0.1%	0.0%
A113	[Anlg In4-20mA Hi] <input type="radio"/>	0.0/100.0%	0.1%	100.0%
A114	[Slip Hertz @ FLA]	0.0/10.0 Hz	0.1 Hz	2.0 Hz
A115	[Process Time Lo]	0.00/99.99	0.01	0.00

No.	Parameter	Min/Max	Display/Options	Default
A116	[Process Time Hi]	0.00/99.99	0.01	0.00
A117	[Bus Reg Mode]	0/1	0 = "Disabled" 1 = "Enabled"	1
A118	[Current Limit 2]	0.1/(Drive Amps × 1.8)	0.1 Amps	Amps × 1.5
A119	[Skip Frequency]	0/400 Hz	1 Hz	0 Hz
A120	[Skip Freq Band]	0.0/30.0 Hz	0.1 Hz	0.0 Hz
A121	[Stall Fault Time]	0/5	0 = "60 Seconds" 1 = "120 Seconds" 2 = "240 Seconds" 3 = "360 Seconds" 4 = "480 Seconds" 5 = "Fit Disabled"	0
A122	[Analog In Loss]	0/6	0 = "Disabled" 1 = "Fault (F29)" 2 = "Stop" 3 = "Zero Ref" 4 = "Min Freq Ref" 5 = "Max Freq Ref" 6 = "Int Freq Ref"	0
A123	[10V Bipolar Enbl]	0/1	0 = "Uni-Polar In" 1 = "Bi-Polar In"	0
A124	[Var PWM Disable]	0/1	0 = "Enabled" 1 = "Disabled"	0
A125	[Torque Perf Mode]	0/1	0 = "V/Hz" 1 = "Sensrls Vect"	1
A126	[Motor NP FLA]	0.1/(Drive Amps × 2)	0.1 Amps	Rated Amps
A127	[Autotune]	0/2	0 = "Ready/Idle" 1 = "Static Tune" 2 = "Rotate Tune"	0
A128	[IR Voltage Drop]	0.0/230.0 VAC	0.1 VAC	Rated Volts
A129	[Flux Current Ref]	0.00/[Motor NP FLA]	0.01 Amps	Rated Amps
A130	[PID Trim Hi]	0.0/400.0	0.1	60.0
A131	[PID Trim Lo]	0.0/400.0	0.1	0.0
A132	[PID Ref Sel]	0/8	0 = "PID Disabled" 1 = "PID Setpoint" 2 = "0-10V Input" 3 = "4-20mA Input" 4 = "Comm Port" 5 = "Setpnt, Trim" 6 = "0-10V, Trim" 7 = "4-20mA, Trim" 8 = "Comm, Trim"	0
A133	[PID Feedback Sel]	0/2	0 = "0-10V Input" 1 = "4-20mA Input" 2 = "Comm Port"	0
A134	[PID Prop Gain]	0.00/99.99	0.01	0.01
A135	[PID Integ Time]	0.0/999.9 Secs	0.1 Secs	0.1 Secs
A136	[PID Diff Rate]	0.00/99.99 (1/Secs)	0.01 (1/Secs)	0.01 (1/Secs)
A137	[PID Setpoint]	0.0/100.0%	0.1%	0.0%
A138	[PID Deadband]	0.0/10.0%	0.1%	0.0%
A139	[PID Preload]	0.0/400.0 Hz	0.1 Hz	0.0 Hz
A140- A147	[Stp Logic 0-7]	0001/bAFF	4 Digits For a list of digit options, refer to the PowerFlex 40 User Manual.	00F1
A150- A157	[Stp Logic Time 0-7]	0.0/999.9 Secs	0.1 Secs	30.0 Secs
A160	[EM Brk Off Delay]	0.01/10.00 Secs	0.01 Secs	2.00 Secs
A161	[EM Brk On Delay]	0.01/10.00 Secs	0.01 Secs	2.00 Secs
A162	[MOP Reset Sel]	0/1	0 = "Zero MOP Ref" 1 = "Save MOP Ref"	1
A163	[DB Threshold]	0.0/110.0%	0.0%	100.0%
A164	[Comm Write Mode]	0/1	0 = "Save" 1 = "RAM Only"	0
A165	[Anlg Loss Delay]	0.0/20.0 Secs	0.1 Secs	0.0 Secs
A166	[Analog In Filter]	0/14	1	0
A167	[PID Invert Error]	0/1	0 = "Not Inverted" 1 = "Inverted"	0

Fault Codes

To clear a fault, press the Stop key, cycle power or set A100 [Fault Clear] to 1 or 2.

No.	Fault	Description
F2	Auxiliary Input ⁽¹⁾	Check remote wiring.
F3	Excessive DC Bus voltage ripple	Monitor the incoming line for phase loss or line imbalance. Then, check input line fuse.
F4	UnderVoltage ⁽¹⁾	Monitor the incoming AC line for low voltage or line power interruption.
F5	OverVoltage ⁽¹⁾	Monitor the AC line for high line voltage or transient conditions. Bus overvoltage can also be caused by motor regeneration. Extend the decel time or install dynamic brake option.
F6	Motor Stalled ⁽¹⁾	Increase [Accel Time x] or reduce load so drive output current does not exceed the current set by parameter A089 [Current Limit].
F7	Motor Overload ⁽¹⁾	An excessive motor load exists. Reduce load so drive output current does not exceed the current set by parameter P033 [Motor OL Current].
F8	Heatsink OvrTmp ⁽¹⁾	Check for blocked or dirty heat sink fins. Verify that ambient temperature has not exceeded 40° C (104° F) for IP 30/NEMA 1/UL Type 1 installations or 50° C (122° F) for Open type installations. Check fan.
F12	HW OverCurrent	Check programming. Check for excess load, improper DC boost setting, DC brake volts set too high or other causes of excess current.
F13	Ground Fault	Check the motor and external wiring to the drive output terminals for a grounded condition.
F29	Analog Input Loss ⁽¹⁾	An analog input is configured to fault on signal loss. A signal loss has occurred.
F33	Auto Rstrt Tries	Correct the cause of the fault and manually clear.
F38	Phase U to Gnd	Check the wiring between the drive and motor. Check motor for grounded phase.
F39	Phase V to Gnd	Replace drive if fault cannot be cleared.
F40	Phase W to Gnd	
F41	Phase UV Short	Check the motor and drive output terminal wiring for a shorted condition.
F42	Phase UW Short	Replace drive if fault cannot be cleared.
F43	Phase VW Short	
F48	Params Defaulted	The drive was commanded to write default values to EEPROM. Clear the fault or cycle power to the drive. Program the drive parameters as needed.
F63	SW OverCurrent ⁽¹⁾	Check load requirements and A098 [SW Current Trip] setting.
F64	Drive Overload	Reduce load or extend Accel Time.
F70	Power Unit	Cycle power. Replace drive if fault cannot be cleared.
F71	Net Loss	The communication network has faulted.
F80	SVC Autotune	The autotune function was either cancelled by the user or failed.
F81	Comm Loss	If adapter was not intentionally disconnected, check wiring to the port. Replace wiring, port expander, adapters or complete drive as required. Check connection. An adapter was intentionally disconnected. Turn off using A105 [Comm Loss Action].
F100	Parameter Checksum	Restore factory defaults.
F122	I/O Board Fail	Cycle power. Replace drive if fault cannot be cleared.

⁽¹⁾ Auto-Reset/Run type fault. Configure with parameters A092 and A093.

Drive Dimensions

PowerFlex 40 Frames – Ratings are in kW and (HP)

Frame	120V AC – 1-Phase	240V AC – 1-Phase	240V AC – 3-Phase	480V AC – 3-Phase	600V AC – 3-Phase
B	0.4 (0.5) 0.75 (1.0) 1.1 (1.5)	0.4 (0.5) 0.75 (1.0) 1.5 (2.0)	0.4 (0.5) 2.2 (3.0) 0.75 (1.0) 3.7 (5.0) 1.5 (2.0)	0.4 (0.5) 2.2 (3.0) 0.75 (1.0) 4.0 (5.0) 1.5 (2.0)	0.75 (1.0) 4.0 (5.0) 1.5 (2.0) 2.2 (3.0)
C ⁽¹⁾		2.2 (3.0)	5.5 (7.5) 7.5 (10.0)	5.5 (7.5) 7.5 (10.0)	5.5 (7.5) 11.0 (15.0) 7.5 (10.0)

(1) IP66, NEMA/UL Type 4X rated drives are not available in Frame C drive ratings.

IP20, NEMA/UL Type Open

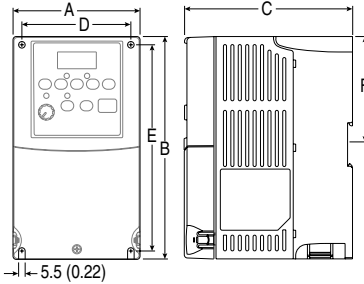

Dimensions are in millimeters and (inches).
Weights are in kilograms and (pounds).

Frame	A	B	C	D	E	F	Ship Weight
B	100 (3.94)	180 (7.09)	136 (5.35)	87 (3.43)	168 (6.61)	87.4 (3.44)	2.2 (4.9)
C	130 (5.1)	260 (10.2)	180 (7.1)	116 (4.57)	246 (9.7)	-	4.3 (9.5)

Communication, RFI Filter, IP 30/NEMA 1/UL Type 1 Option Kits

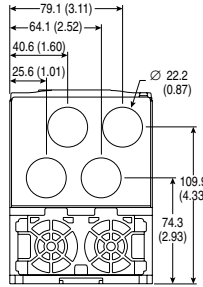
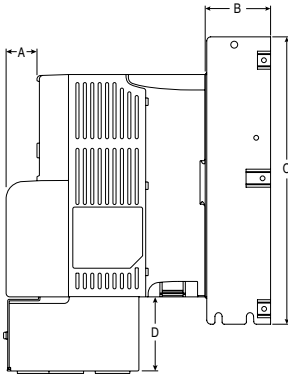

B Frame - 22-JBAB

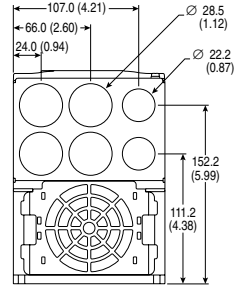

C Frame - 22-JBAB

Dimension	Option	B Frame Drive	C Frame Drive
A	Comm Cover	25 (0.98)	25 (0.98)
B	EMC Line Filter	50 (1.97)	60 (2.36)
C	EMC Line Filter	229 (9.02)	309 (12.17)
D	IP30/NEMA 1/UL Type 1	33 (1.30)	60 (2.36)
	IP30/NEMA 1/UL Type 1 for Comm Cover	64 (2.52)	60 (2.36)

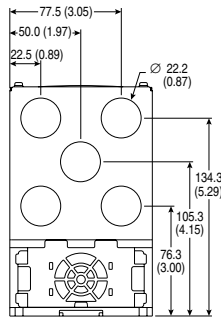

B Frame - 22-JBCB
(used with Comm Cover)

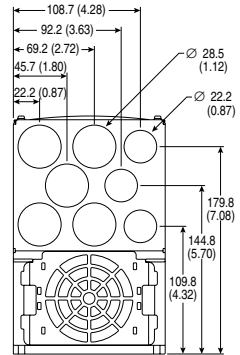

C Frame - 22-JBCB
(used with Comm Cover)

IP66, NEMA Type/UL Type 4X – Dimensions are in millimeters and (inches) Weights are in kilograms and (pounds).

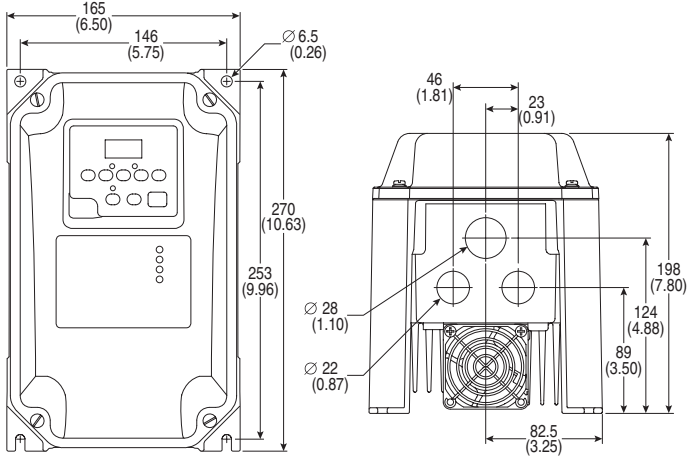

Weight

5.2 (11.5)

www.rockwellautomation.com

Power, Control and Information Solutions Headquarters

Americas: Rockwell Automation, 1201 South Second Street, Milwaukee, WI 53204-2496 USA, Tel: (1) 414.382.2000, Fax: (1) 414.382.4444
Europe/Middle East/Africa: Rockwell Automation, Vorstlaan/Boulevard du Souverain 36, 1170 Brussels, Belgium, Tel: (32) 2 663 0600, Fax: (32) 2 663 0640
Asia Pacific: Rockwell Automation, Level 14, Core F Cyberport 3, 100 Cyberport Road, Hong Kong, Tel: (852) 2887 4788, Fax: (852) 2508 1846

Publication 22B-QS001F-EN-P – December 2008

Supersedes May 2008

Copyright © 2008 Rockwell Automation, Inc. All rights reserved.